



InvenSense Inc.
1197 Borregas Ave, Sunnyvale, CA 94089 U.S.A.
Tel: +1 (408) 988-7339 Fax: +1 (408) 988-8104
Website: www.invensense.com

PS-IXZ-0650B-00-03
Release Date: 05/20/10

IXZ-650 Dual-Axis Gyro Product Specification

A printed copy of this document is
NOT UNDER REVISION CONTROL
unless it is dated and stamped in red ink as,
"REVISION CONTROLLED COPY."

This information furnished by InvenSense is believed to be accurate and reliable. However, no responsibility is assumed by InvenSense for its use, or for any infringements of patents or other rights of third parties that may result from its use. Specifications are subject to change without notice. InvenSense reserves the right to make changes to this product, including its circuits and software, in order to improve its design and/or performance, without prior notice. InvenSense makes no warranties, neither expressed nor implied, regarding the information and specifications contained in this document. InvenSense assumes no responsibility for any claims or damages arising from information contained in this document, or from the use of products and services detailed therein. This includes, but is not limited to, claims or damages based on the infringement of patents, copyrights, mask work and/or other intellectual property rights.

Certain intellectual property owned by InvenSense and described in this document is patent protected. No license is granted by implication or otherwise under any patent or patent rights of InvenSense. This publication supersedes and replaces all information previously supplied. Trademarks that are registered trademarks are the property of their respective companies. InvenSense sensors should not be used or sold in the development, storage, production or utilization of any conventional or mass-destructive weapons or any other weapons or life threatening applications, as well as in any other life critical applications such as medical equipment, transportation, aerospace and nuclear instruments, undersea equipment, power plant equipment, disaster prevention and crime prevention equipment.



TABLE OF CONTENTS

1. REVISION HISTORY	4
2. PURPOSE.....	5
3. PRODUCT OVERVIEW	5
4. FEATURES.....	5
5. FUNCTIONAL BLOCK DIAGRAM.....	6
6. FUNCTIONAL DESCRIPTION	6
6.1 OVERVIEW	6
6.2 RATE SENSORS	6
6.3 OSCILLATOR CIRCUIT.....	6
6.4 AMPLITUDE CONTROL	7
6.5 CORIOLIS SENSE	7
6.6 DEMODULATOR.....	7
6.7 LOW-PASS FILTER	7
6.8 AUTO ZERO.....	7
6.9 TEMPERATURE SENSOR.....	7
6.10 CHARGE PUMP	7
6.11 MEMORY TRIM.....	7
6.12 SCALE FACTOR	7
6.13 REFERENCE VOLTAGE	7
6.14 ANALOG OUTPUTS.....	7
7. SPECIFICATION.....	8
7.1 SPECIFIED PARAMETERS.....	8
7.2 RECOMMENDED OPERATING CONDITIONS.....	9
7.3 ABSOLUTE MAXIMUM RATINGS	9
7.4 REFERENCE CIRCUIT	10
7.4.1 BILL OF MATERIAL FOR EXTERNAL COMPONENTS.....	10
8. APPLICATION INFORMATION	11
8.1 PIN OUT AND SIGNAL DESCRIPTION	11
8.2 DESIGN CONSIDERATIONS.....	12
8.2.1 POWER SUPPLY REJECTION RATIO.....	12
8.2.2 POWER SUPPLY FILTERING	12
8.2.3 AMPLITUDE CONTROL	12
8.2.4 TEMPERATURE SENSOR	12
8.2.5 INTERNAL LOW-PASS FILTER.....	12



**IXZ-650 Dual-Axis Gyroscope
Product Specification**

PS-IXZ-0650B-00-03
Release Date: 05/20/10

8.2.6	EXTERNAL LOW-PASS CIRCUITRY	13
8.2.7	GYRO OUTPUTS	13
8.2.8	AUTO ZERO	14
8.2.9	HIGH IMPEDANCE NODES	14
8.2.10	PROPER INTERFACE CLEANING.....	14
8.2.11	ACOUSTIC NOISE SENSITIVITY	14
8.2.12	ELECTROSTATIC DISCHARGE SENSITIVITY	14
9.	ASSEMBLY	15
9.1	ORIENTATION	15
9.2	PCB MOUNTING AND CROSS-AXIS SENSITIVITY	16
9.3	PACKAGE DIMENSIONS	17
9.4	PACKAGE MARKING SPECIFICATION.....	18
9.5	TAPE & REEL SPECIFICATION	18
9.5.1	LABEL	20
9.5.2	PACKING	20
9.6	PCB PAD LAYOUT DIMENSIONS	21
9.7	TRACE ROUTING.....	21
9.8	SOLDERING EXPOSED DIE PAD	21
9.9	COMPONENT PLACEMENT	21
9.10	AGC NODES	21
9.11	MEMS HANDLING INSTRUCTIONS.....	21
9.12	GYROSCOPE SURFACE MOUNT GUIDELINES	22
9.13	REFLOW SPECIFICATION	22
9.14	STORAGE SPECIFICATION	23
10.	RELIABILITY	24
10.1	QUALIFICATION TEST POLICY	24
10.2	QUALIFICATION TEST PLAN	24
11.	ENVIRONMENTAL COMPLIANCE.....	25

	IXZ-650 Dual-Axis Gyroscope Product Specification	PS-IXZ-0650B-00-03 Release Date: 05/20/10
---	--	--

1. Revision History

Revision Date	Revision	Description
06/04/09	01	Initial Release
04/13/10	02	Removed confidentiality mark
05/20/10	03	Updated AutoZero section to include pin connection recommendation when AZ function not used.



2. Purpose

The purpose of this document is to provide a detailed product description and design-related information regarding the IXZ-650 dual-axis gyroscope.

3. Product Overview

The IXZ™ family of dual-axis MEMS gyroscopes feature the world's first roll/yaw (X and Z-axis) MEMS gyros that meet the in-plane mounting requirements of remote controls and interactive game controllers for digital TVs, IPTVs, set top boxes, media centers and PCs. Traditionally, designers of remote controls have had to use two single Z-axis or one dual-axis X/Y gyroscope, which because of their axes of sensitivity, required a daughter card for mounting the angular rate sensors perpendicular to the rest of the system electronics. The in-plane mounting of the IXZ family overcomes this limitation, enabling compelling form-factor designs.

The IXZ-650 is uniquely suited for motion-controlled remote controls with immersive gaming capability. The device features a primary output with a $\pm 2000^\circ/\text{sec}$ full scale range, for measuring higher speed gaming motions, and has a secondary output with a $\pm 440^\circ/\text{sec}$ full-scale range, for gesture and menu-navigation functionality.

The IXZ-650 leverages InvenSense's patented and volume-proven Nasiri-Fabrication platform, which integrates MEMS wafers with companion CMOS electronics through wafer-level bonding to produce a functionally complete, low-cost motion sensor. All required conditioning electronics are integrated into a single chip measuring 4x5x1.2mm. It incorporates X- and Z-axis low-pass filters and an EEPROM for on-chip factory calibration of the sensor. Factory trimmed scale factors eliminate the need for external active components and end-user calibration. A built-in Proportional-To-Absolute-Temperature (PTAT) sensor provides temperature compensation information. The product is RoHS and Green Compliant.

4. Features

- Integrated X- and Z-axis gyros on a single chip with in-plane mounting
- Two separate outputs per axis for high-speed gaming applications and lower-speed menu navigation:
 - $2000^\circ/\text{s}$ full scale range (higher speed)
 - $440^\circ/\text{s}$ full scale range (high precision)
- Integrated amplifiers and low-pass filters
- Auto Zero function for bias calibration
- On-chip temperature sensor
- High vibration rejection over a wide frequency range
- High cross-axis isolation by proprietary MEMS design
- 3V single supply operation
- Hermetically sealed for temp and humidity resistance
- 10,000 g shock tolerant
- Smallest dual axis gyro package at 4mm x 5mm x 1.2mm
- RoHS and Green Compliant

5. Functional Block Diagram

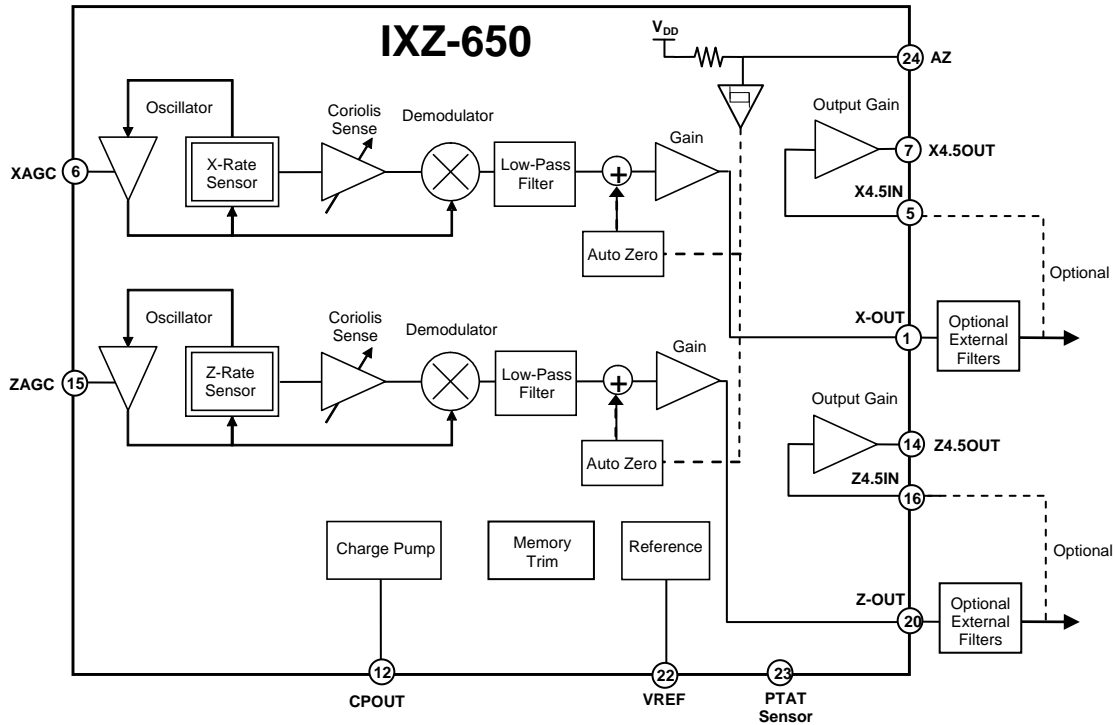

Figure 1

6. Functional Description

6.1 Overview

The IXZ-650 gyroscope consists of two independent vibratory MEMS gyroscopes. One detects rotation about the X-axis; the other detects rotation about the Z-Axis.

The gyroscope's proof-masses are electrostatically oscillated at resonance. An internal automatic gain control circuit precisely controls the oscillation of the proof masses. When the sensor is rotated about the X- or Z-Axis, the Coriolis Effect causes a vibration that can be detected by a capacitive pickoff. The resulting signal is amplified, demodulated, and filtered to produce an analog voltage that is proportional to the angular rate.

6.2 Rate Sensors

The mechanical structures for detecting angular rate about the X- and Z-axes are fabricated using InvenSense's proprietary bulk silicon technology. The structures are covered and hermetically sealed at the wafer level. The cover shields the gyro from electromagnetic and radio frequency interferences (EMI/RFI). The dual-mass design inherently rejects any signal caused by linear acceleration. The X-gyro and the Z-gyro have different resonant frequencies to prevent undesired coupling.

6.3 Oscillator Circuit

The oscillator circuit generates electrostatic forces to vibrate the structure at resonance. The circuit detects the vibration by measuring the capacitance between the oscillating structure and a fixed electrode. The oscillator circuit switches in quadrature phase with the capacitance measurement in order to vibrate at resonance.



6.4 Amplitude Control

The scale factor of the gyroscope depends on the amplitude of the mechanical motion and the trim setting of the internal programmable gain stages. The oscillation circuit precisely controls the amplitude to maintain constant sensitivity over the temperature range. The capacitors ($0.22\mu\text{F} \pm 10\%$) connected to Pin 6 (XAGC) and Pin 15 (ZAGC) are compensation capacitors for the amplitude control loops.

6.5 Coriolis Sense

Rotating the sensor about the X- or Z-Axis results in a Coriolis force on the corresponding X- or Z-rate sensor. The Coriolis force causes the mechanical structure to vibrate. The resulting vibration is detected by measuring the capacitance change between the mechanical structure and fixed electrodes. This signal is converted to a voltage waveform by means of low-noise charge integrating amplifier and amplification stages.

6.6 Demodulator

The output of the Coriolis sense is an amplitude modulated waveform. The amplitude corresponds to the rotation rate, and the carrier frequency is the mechanical drive frequency. The synchronous demodulator converts the Coriolis sense waveform to the low-frequency, angular rate signal.

6.7 Low-Pass Filter

After the demodulation stage, there is a low-pass filter. This filter attenuates noise and high frequency artifacts before final amplification.

6.8 Auto Zero

The Auto Zero function is used to reduce DC offset caused by bias drift. The use of this function will vary by application requirement. Pin 24 (AZ) is used to set the Auto Zero function, resetting the bias to approximately VREF.

6.9 Temperature Sensor

A built-in Proportional-To-Absolute-Temperature (PTAT) sensor provides temperature information on Pin 23.

6.10 Charge Pump

The on-chip charge pump generates the voltage required to oscillate the mechanical structure.

6.11 Memory Trim

The on-chip memory is used to select the gyro's sensitivity, calibrate the sensitivity, null DC offsets and select the low-pass filter option

6.12 Scale Factor

The Rate-Out of the gyro is not ratiometric to the supply voltage. The scale factor is calibrated at the factory and is nominally independent of supply voltage.

6.13 Reference Voltage

The gyro includes a bandgap reference circuit. The output voltage is typically 1.35V and is nominally independent of temperature. The zero-rate signal is nominally equal to the reference value.

6.14 Analog Outputs

The IXZ-650 gyro has two X-outputs (X-OUT and X4.5OUT) and two Z-outputs (Z-OUT and Z4.5OUT), with scale factors and full-scale sensitivities that vary by a factor of 4.5, as detailed in Section 8.2.7.

Having two sensitivities and two full-scale ranges per output allows the end user to have one output that can be used for faster motions (over a full scale range of $\pm 2000^\circ/\text{sec}$), and a second output that can be used for slower motions (over a full scale range of $\pm 440^\circ/\text{sec}$). Thus a lower-resolution analog-to-digital converter (ADC) may be used to digitize the motion, with the gain of 4.5 in the `_4.5OUT` output effectively giving the user additional two-plus bits of resolution.



**IXZ-650 Dual-Axis Gyroscope
Product Specification**

PS-IXZ-0650B-00-03
Release Date: 05/20/10

7. Specification

7.1 Specified Parameters

All parameters specified are @ VDD = 3.0 V and T_A = 25°C. External LPF @ 2kHz. All specifications apply to both axes.

PARAMETER	CONDITIONS		MIN	TYP	MAX	UNITS
SENSITIVITY						
Full-Scale Range	At X-OUT and Z-OUT			±2000		°/s
	At X4.5OUT and Z4.5OUT			±440		°/s
Sensitivity	At X-OUT and Z-OUT			0.5		mV/°/s
	At X4.5OUT and Z4.5OUT			2.27		mV/°/s
Initial Calibration Tolerance	At X-OUT and Z-OUT			±6		%
Calibration Drift Over Specified Temperature	At X-OUT and Z-OUT			±10		%
Nonlinearity	At X-OUT and Z-OUT, Best Fit Straight Line			<1		% of FS
Cross-axis Sensitivity				±1		%
REFERENCE						
Voltage (VREF)				1.35		V
Tolerance				±50		mV
Load Drive				100		µA
Capacitive Load Drive	Load directly connected to VREF			100		pF
Power Supply Rejection	VDD= 2.7V to 3.3V			5		mV/V
Reference Drift Over Specified Temperature				±5		mV
ZERO-RATE OUTPUT (ZRO)						
Static Output (Bias)	Factory Set			1.35		V
Initial Calibration Tolerance	Relative to VREF	With Auto Zero		±20		mV
		Without Auto Zero		±150		
ZRO Drift Over Specified Temperature				±20		mV
Power Supply Sensitivity	@ 50 Hz			50		°/sec/V
FREQUENCY RESPONSE						
High Frequency Cutoff	Internal LPF -90°			140		Hz
LPF Phase Delay	10Hz			-4.5		°
MECHANICAL FREQUENCIES						
X-Axis Resonant Frequency			20	24	28	kHz
Z-Axis Resonant Frequency			26	30	34	
Frequency Separation	X and Z Gyroscopes			6		
NOISE PERFORMANCE						
Total RMS Noise	Bandwidth 1Hz to 1kHz, At X-OUT and Z-OUT			0.3		mV rms
OUTPUT DRIVE CAPABILITY						
Output Voltage Swing	Load = 100kΩ to V _{dd} /2		0.05		V _{dd} -0.05	V
Capacitive Load Drive				100		pF
Output Impedance				200		Ω
POWER ON-TIME						
Zero-rate Output	Settling to ±5°/s			50		ms
AUTO ZERO CONTROL						
Auto Zero Logic High	Rising Input			1.9		V
Auto Zero Logic Low	Falling Input			0.9		V
Auto Zero Pulse Duration			2		1500	µsec
Offset Settle Time After Auto Zero				7		msec



IXZ-650 Dual-Axis Gyroscope Product Specification

PS-IXZ-0650B-00-03
Release Date: 05/20/10

PARAMETER	CONDITIONS	MIN	TYP	MAX	UNITS
POWER SUPPLY (VDD) Operating Voltage Range Quiescent Supply Current Supply Current Change Over Specified Temperature		2.7	3.0 6.5 ±2	3.3	V mA mA
TEMPERATURE SENSOR Sensitivity Offset Output Impedance	Range -20 to +85°C		4 1.25 12		mV/°C V kΩ
TEMPERATURE RANGE Specified Temperature Range		-20		+85	°C

7.2 Recommended Operating Conditions

Parameter	Min	Typ	Max	Unit
Power Supply Voltage (VDD)	2.7	3.0	3.3	V
Power Supply Voltage (VDD) Rise Time (10% - 90%)			20	ms

7.3 Absolute Maximum Ratings

Stress above those listed as “Absolute Maximum Ratings” may cause permanent damage to the device. This is a stress rating only and functional operation of the device under these conditions is not implied. Exposure to the absolute maximum rating conditions for extended periods may affect device reliability.

Parameter	Rating
Supply Voltage	-0.3V to +3.6V
Acceleration (Any Axis, unpowered)	10,000g for 0.3ms
Operating Temperature Range	-40 to +105°C
Storage Temperature Range	-40 to +125°C

7.4 Reference Circuit

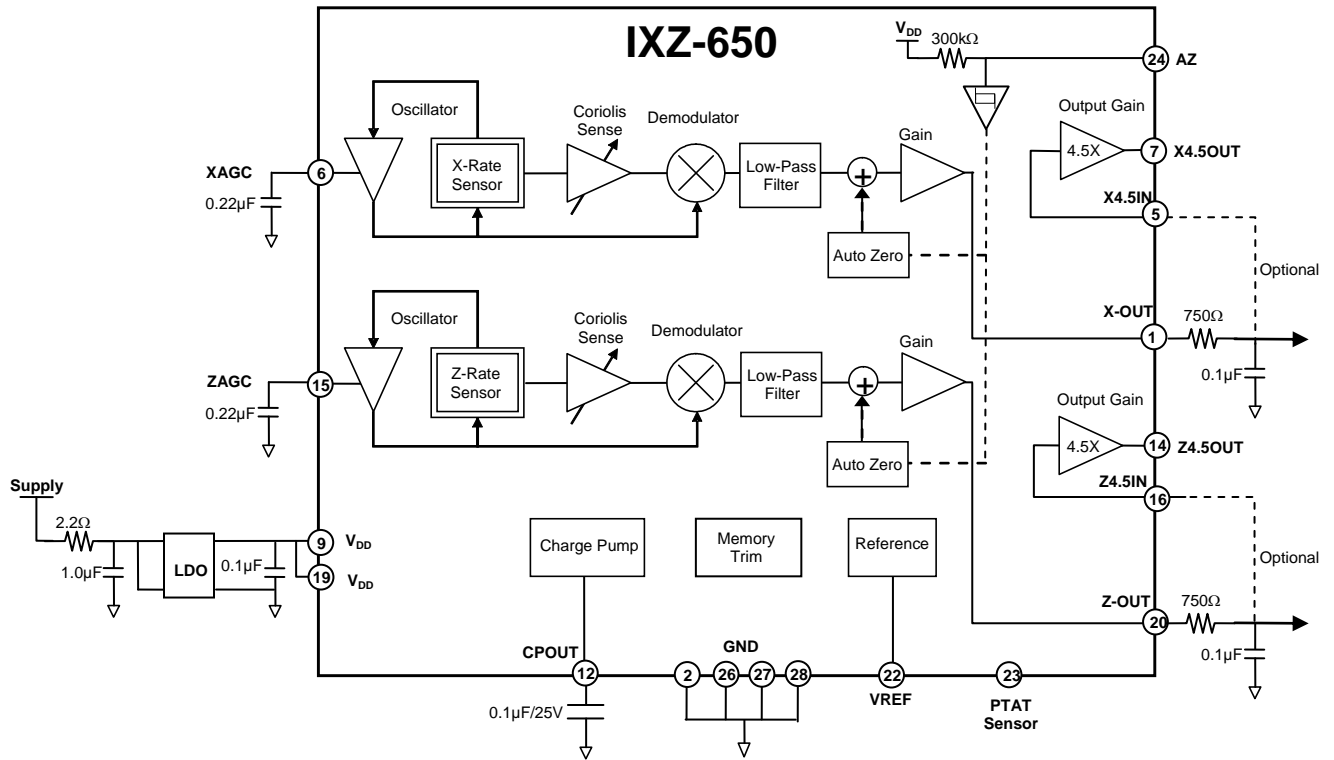

Figure 2

7.4.1 Bill of Material for External Components

Component	Specification
Low Pass Filter Capacitors	0.1μF ±20% / 10V
AGC Capacitors	0.22μF ±10% / 10V
VDD Bypass Capacitor	0.1μF ±20% / 10V
Charge Pump Capacitor	0.1μF ±20% / 25V
LDO Input Filter Capacitor	1.0μF / Ratings Dependent upon Supply Voltage
LDO Input Filter Resistor	2.2Ω ±1%
Low Pass Filter Resistors	750Ω ±1%



8. Application Information

8.1 Pin Out and Signal Description

Number	Pin	Description
2, 8, 26, 27, 28	GND	Ground
9, 19	VDD	Positive supply voltage
1	X-OUT	Rate output for rotation about the X-axis
5	X4.5IN	X-axis input to the 4.5X amplifier
6	XAGC	Amplitude control capacitor connection
7	X4.5OUT	X-axis output of the 4.5X amplifier
12	CPOUT	Charge pump capacitor connection
14	Z4.5OUT	Z-Axis output of the 4.5X amplifier
15	ZAGC	Amplitude control capacitor connection
16	Z4.5IN	Z-Axis input to the 4.5X amplifier
20	Z-OUT	Rate output for rotation about the Z-Axis
22	VREF	Precision reference output
23	PTATS	Temperature Sensor Output
24	AZ	X & Z Auto Zero control pin
10, 11, 13, 21, 25	RESV	Reserved. Do not connect.
3, 4, 17, 18	NC	Not internally connected. May be used for PCB trace routing.

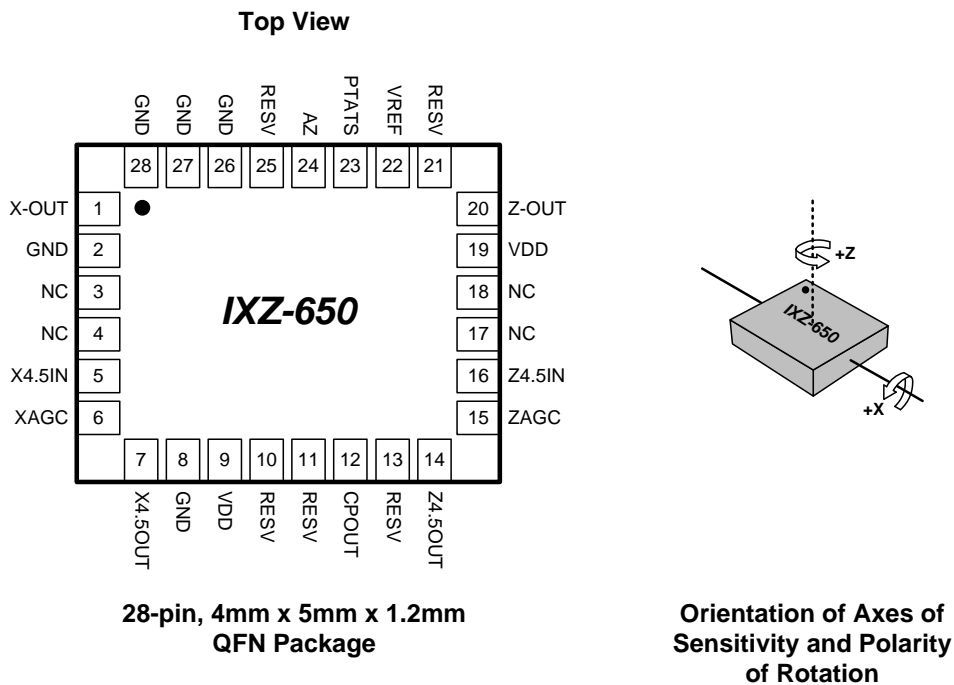

Figure 3

8.2 Design Considerations

8.2.1 Power Supply Rejection Ratio

The gyro is most susceptible to power supply noise (ripple) at frequencies less than 100Hz. At less than 100Hz, the PSRR is determined by the overall internal gain of the gyroscope. Above 100Hz, the PSRR is determined by the characteristics of the on-chip low-pass filter. Above 1kHz, the PSRR is relatively constant except for two narrow frequency ranges corresponding to the resonant frequencies of the X and Z gyroscopes.

8.2.2 Power Supply Filtering

NOTE: Power supply Voltage (VDD) rise time (10% - 90%) must be less than 20 ms, at VDD (pins 9 and 19), for proper device operation.

The IXZ-650 gyro should be isolated from system power supply noise by a combination of an RC filter that attenuates high frequency noise and a Low Drop Out power supply regulator (LDO) that attenuates low frequency noise. The figure below shows a typical configuration.

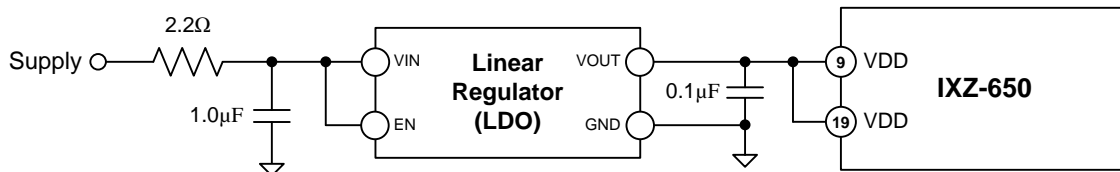

Figure 4

The low-pass RC filter should be chosen such that it provides significant attenuation of system noise at high frequencies. The LDO should be a low noise regulator ($<100\mu\text{V}/\text{rtHz}$) that exhibits good noise rejection at low frequencies.

8.2.3 Amplitude Control

The scale factor of the gyroscope depends on the amplitude of the mechanical motion and the trim setting of the internal programmable gain stages. The oscillation circuit precisely controls the amplitude to maintain constant sensitivity over the temperature range. The capacitors ($0.22\mu\text{F}$, $\pm 10\%$) connected to Pin 6 (XAGC) and Pin 15 (ZAGC) are compensation capacitors for the amplitude control loops.

8.2.4 Temperature Sensor

A built-in Proportional-To-Absolute-Temperature (PTAT) sensor provides temperature information on Pin 23 (PTATS). The temperature sensor output signal is analog, and has a bias of approximately 1.25V at room temperature, and increases at a rate of $4\text{mV}/^\circ\text{C}$. The output impedance is nominally $12\text{k}\Omega$ and is therefore not designed to drive low impedance loads. If necessary, the output can be externally buffered with a low offset-drift buffer, and optionally a low-pass filter to minimize noise.

8.2.5 Internal Low-Pass Filter

After the demodulation stage, there is a low-pass filter. This filter limits noise and high frequency artifacts from the demodulator before final amplification. The following graph shows the typical gain and phase response. The low-pass filter has been designed for a nominally flat gain up to the cutoff frequency while still achieving a low phase delay at 10Hz and 30Hz.

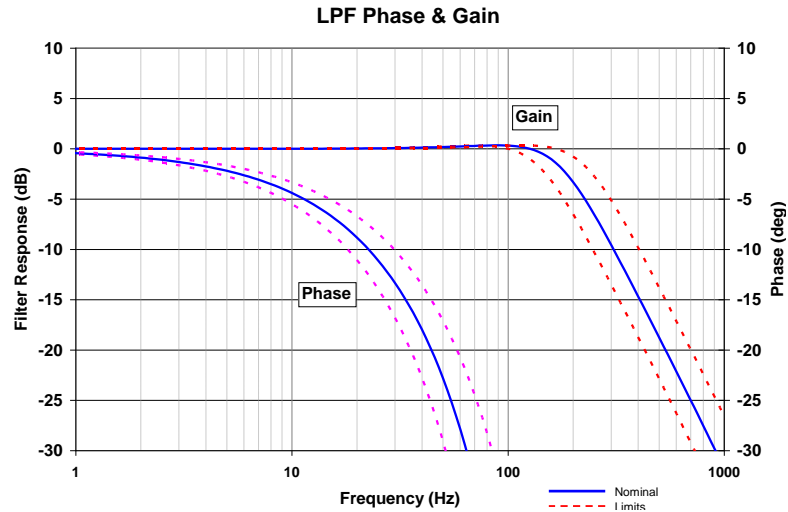

Figure 5

8.2.6 External Low-Pass Circuitry

To further attenuate high-frequency noise, an optional external low-pass filter may be used.

8.2.7 Gyro Outputs

The IXZ-650 gyro has two X-outputs and two Z-outputs, with scale factors and full-scale sensitivities as summarized below.

Axis	Gyro Output	Sensitivity (mV/°/s)	Full-Scale Range (±°/s)
X	X-OUT	0.5	2000
	X4.5OUT	2.27	440
Z	Z-OUT	0.5	2000
	Z4.5OUT	2.27	440

Having two sensitivities and two full-scale ranges per axis allows the end user to have one output that can be used for faster motions such as full-motion gaming (over a full scale range of ±2000°/sec), and a second output that can be used for slower motions such as for gesture and menu-navigation functionality (over a full scale range of ±440°/sec). Thus a lower-resolution analog-to-digital converter (ADC) may be used to digitize the motion, with the gain of 4.5 in the _4.5OUT output effectively giving the user an additional two-plus bits of resolution.

The IXZ-650 gyro outputs are independent of supply voltage (i.e. they are not ratiometric).

Gyro rotation rate is calculated as:

$$(Gyro\ Output\ Voltage - Gyro\ Zero-Rate\ Out) / Sensitivity$$

where the Zero-Rate Output (ZRO) is nominally VREF. There is a temperature dependence to ZRO, and an initial accuracy to ZRO.

8.2.8 Auto Zero

Auto Zero (AZ) is a function that is used to maximize the gyro's dynamic range when using the _4.5OUT outputs.

AZ works by keeping the gyro's Zero-Rate Output (ZRO) close to VREF, and thus allows the user to achieve a wider usable signal range, without using external analog high pass filters.

When activated, the Auto Zero circuit internally nulls the ZRO to VREF. The typical usage of Auto Zero is in conditions where:

1. The gyro's motion is known, such as when:
 - a. The gyro is stationary.
 - b. Other sensors can report angular rotation rate.
2. The DC value of the gyro output is not important, but only the AC value is. In this case, a digital ac filter may be used to extract the gyro data, which provides a higher-quality output than is possible with an analog R-C filter.

The Auto Zero function is initiated on the rising edge of the AZ pin. The Auto Zero settling time is typically 7ms. This time includes the time required for nulling the ZRO and for the settling of the internal low pass filter (LPF). If the external LPF bandwidth is less than 200Hz, the Auto Zero settling time will be longer than specified.

The AZ pulse width should meet the specified minimum time requirement of 2 μ s to start the Auto Zero function, and should be shorter than the maximum specified time of 1,500 μ s. The Auto Zero pulse should occur after the start-up period to cancel any initial calibration error.

If the AutoZero function is not used, the AZ pin (pin 24) should be connected to ground.

8.2.9 High Impedance Nodes

XAGC (pin 6) and ZAGC (pin 15) pins are high impedance (>1Mohm) nodes. Any coating, glue or epoxy on these pins or on the capacitors connected to these pins, will affect part performance and should be avoided.

8.2.10 Proper Interface Cleaning

Proper cleaning of PCB solder pads prior to assembly is recommended. PCB surface contaminants at XAGC (pin 6) or ZAGC (pin 15) device interfaces may affect part performance.

8.2.11 Acoustic Noise Sensitivity

The IXZ-650 gyroscope is insensitive to acoustic vibration except for a narrow frequency range near the gyro's resonant frequency. The typical bandwidth of the acoustic sensitivity is 200Hz. It is recommended that products using the IXZ-650 gyroscope be designed such that the acoustic noise in the 20kHz to 31kHz range be attenuated by the product's enclosure.

8.2.12 Electrostatic Discharge Sensitivity

The IXZ-650 gyroscope can be permanently damaged by an electrostatic discharge. ESD precautions for handling and storage are recommended.

9. Assembly

9.1 Orientation

The diagram below shows the orientation of the axes of sensitivity and the polarity of rotation.

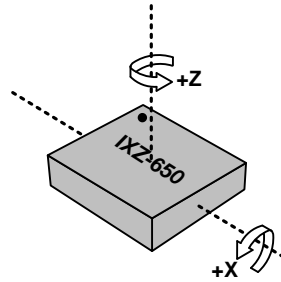

Figure 6

9.2 PCB Mounting and Cross-Axis Sensitivity

Orientation errors of the gyroscope mounted to the printed circuit board can cause cross-axis sensitivity in which one gyro responds to rotation about another other axis, for example, the X-axis gyroscope responding to rotation about the Y or Z axes. The orientation mounting errors are illustrated in the figure below.

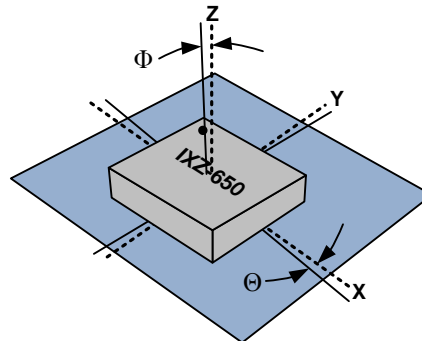

Figure 7. Package Gyro Axes (.....) Relative to PCB Axes (———) with Orientation Errors (Θ and Φ)

The table below shows the cross-axis sensitivity as a percentage of the specified gyroscope’s sensitivity for a given orientation error.

Cross-Axis Sensitivity vs. Orientation Error

Orientation Error (θ or Φ)	Cross-Axis Sensitivity ($\sin\theta$ or $\sin\Phi$)
0°	0%
0.5°	0.87%
1°	1.75%

The specification for cross-axis sensitivity in Section 7 includes the effect of the die orientation error with respect to the package.

9.3 Package Dimensions

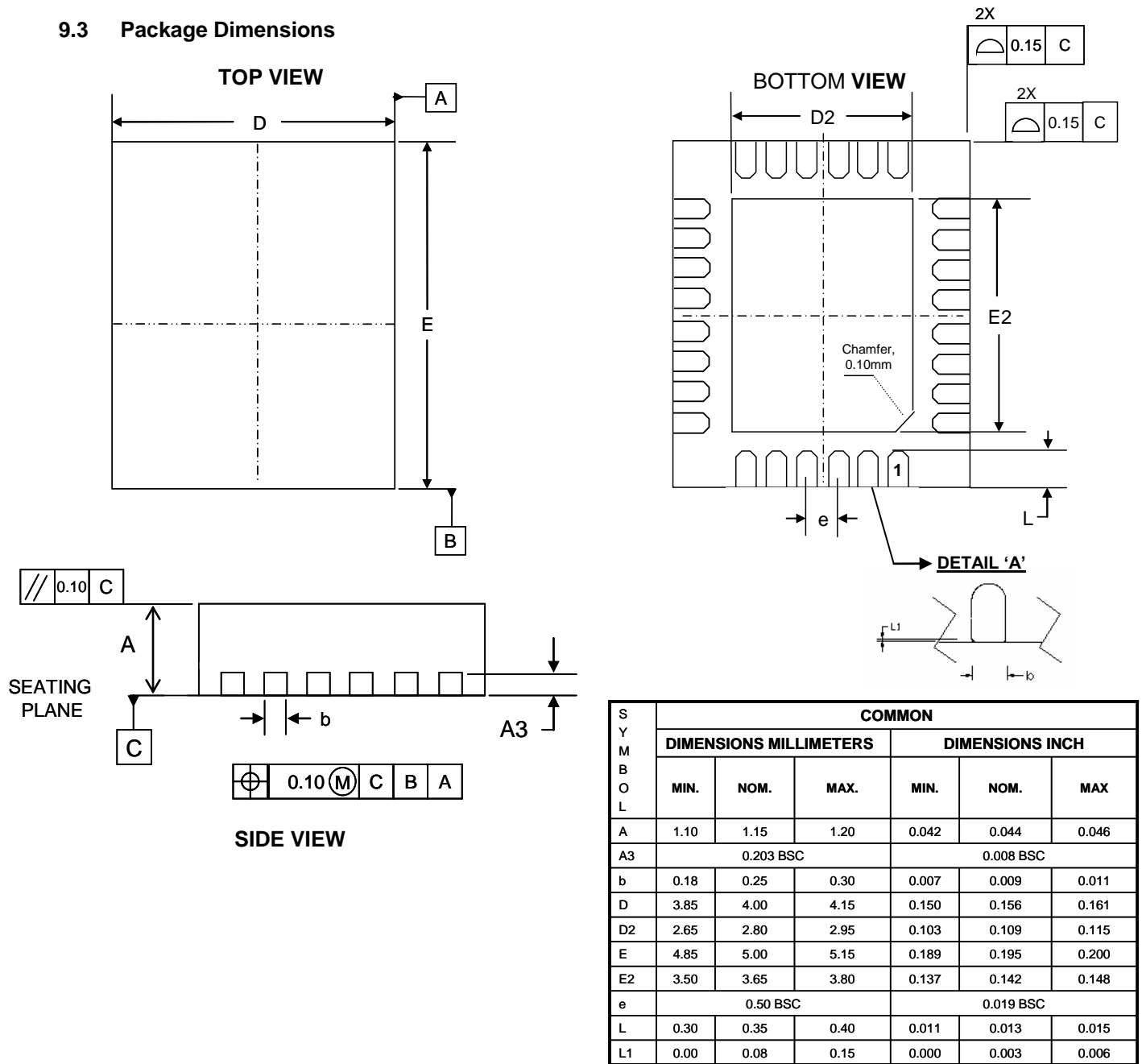
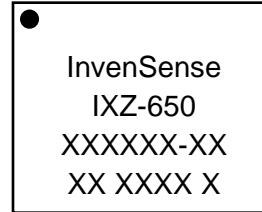

Figure 7



9.4 Package Marking Specification

- Line 1 = Company Name
- Line 2 = Part Number
- Line 3 = Lot Traceability Code
- Line 4 = Fabricator, Assembly, Date Code, Revision



Top View

9.5 Tape & Reel Specification

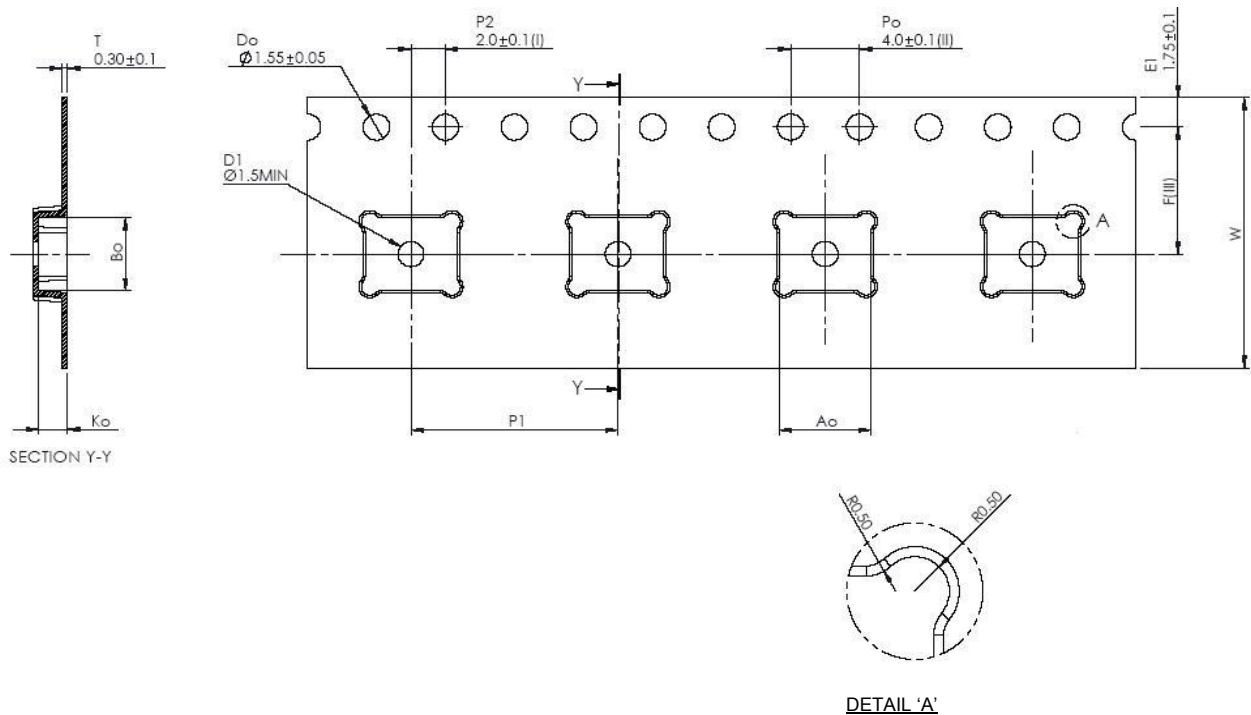

- (I) Measured from centerline of sprocket hole to centerline of pocket.
 - (II) Cumulative tolerance of 10 sprocket holes is ± 0.20 .
 - (III) Measured from centerline of sprocket holes to centerline of pocket.
 - (IV) Other material available.
- ALL DIMENSIONS IN MILLIMETERS UNLESS OTHERWISE STATED.

Figure 12

PKG SIZE	CARRIER TAPE (mm)							
	Tape Width (W)	Pocket Pitch (P1)	Ao	Bo	Ko	F	Leader Length (Min.)	Trailer Length (Min.)
4x5	16.00 ± 0.3	12.00 ± 0.1	5.30 ± 0.1	4.30 ± 0.1	1.65 ± 0.1	7.50 ± 0.1	300	300

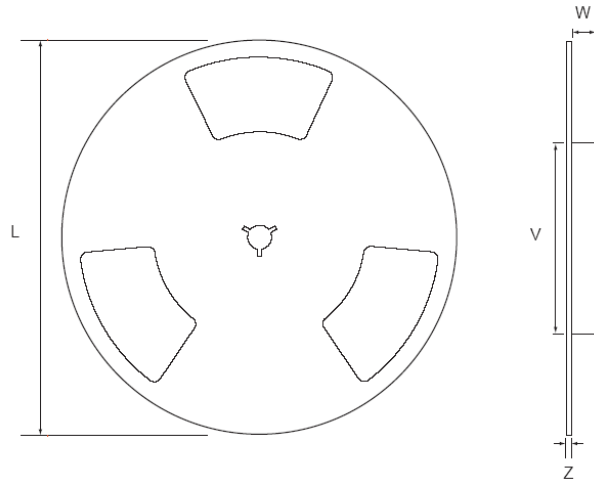

Figure 8

PKG SIZE	REEL (mm)			
	L	V	W	Z
4x5	330	100	16.4	3.0

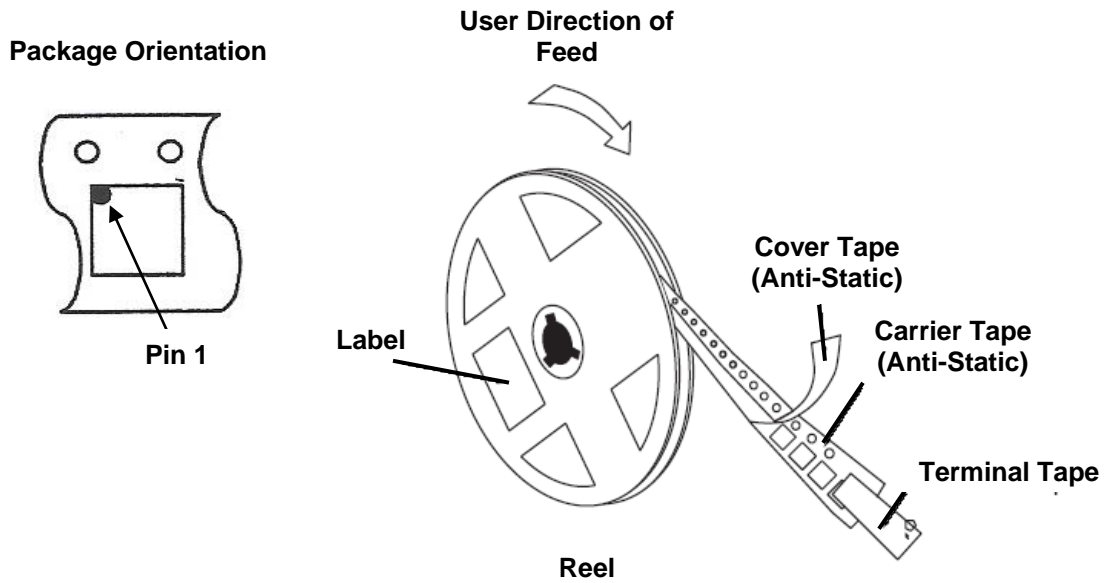









Figure 9

Quantity Per Reel	5000
Reels per Pizza Box	1
Pizza Boxes Per Carton (max)	3 full pizza boxes packed in the center of the carton, buffered by two empty pizza boxes (front and back).
Pieces/Carton (max)	15,000

9.5.1 Label

InvenSense			
DEVICE (1P) : IXZ-650	P.O.:	REEL QTY (Q) :3000	
			
LOT 1 (1T) : 123456-07	D/C (D) : 0915	QTY (Q) : 3000	
			
LOT 2 (1T) :	D/C (D) :	QTY (Q) :	
			
Reel Date : 28/04/09		QC STAMP	



Location of Label

9.5.2 Packing



**Moisture Barrier Bag
With Labels**

- ← Anti-static Label
- ← Moisture-Sensitive Caution Label
- ← Tape & Reel Label

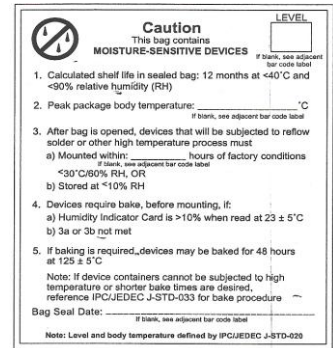

Moisture-Sensitive Caution Label



Reel in Pizza Box



Pizza Box with Tape & Reel Label

9.6 PCB Pad Layout Dimensions

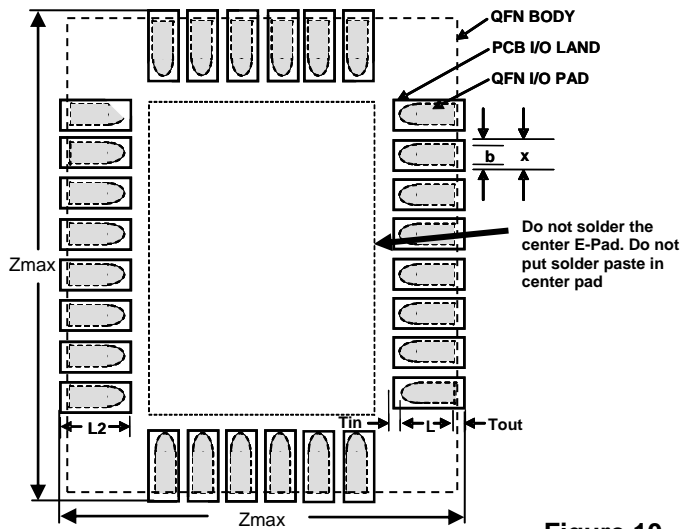

Figure 10

NOMINAL PACKAGE I/O PAD DIMENSIONS (mm)	
Pad Pitch	0.50
Pad Width (b)	0.25
Pad Length (L)	0.40
I/O LAND DESIGN DIMENSIONS GUIDELINES (mm)	
Land Width (x)	0.30
Outward Extension (Tout)	0.05
Inward Extension (Tin)	0.05
Land Length (L2)	0.50
Sq. Stencil Openings (c)	0.5 x 0.5
Maximum Dimension (Zmax)	4.9 x 5.9

9.7 Trace Routing

Testing indicates that 3-Volt peak-to-peak signals run under the gyro package or directly on top of the package of frequencies from DC to 1MHz do not affect the operation of the MEMS gyro. However, routing traces or vias under the MEMS gyro package such that they run under the exposed die pad is prohibited.

9.8 Soldering Exposed Die Pad

The IXZ-650 has very low active and standby current consumption. The exposed die pad is not required for heat sinking, and should not be soldered to the PCB since soldering to it contributes to performance changes due to package thermo-mechanical stress.

9.9 Component Placement

Testing indicates that there are no specific design considerations other than generally accepted industry design practices for component placement near the MPU-3100 multi-axis gyroscope to prevent noise coupling, and thermo-mechanical stress.

9.10 AGC Nodes

The gyro pins marked XAGC and ZAGC are high impedance nodes that are sensitive to current leakage, which can impact gyroscope performance. Care should be taken to ensure that these nodes are not contaminated by residue such as flux and are clean.

9.11 MEMS Handling Instructions

MEMS (Micro Electro-Mechanical Systems) are a time-proven, robust technology used in hundreds of millions of consumer, automotive and industrial products. MEMS devices consist of microscopic moving mechanical structures. They differ from conventional IC products even though they can be found in similar packages. Therefore, MEMS devices require different handling precautions than conventional ICs prior to mounting onto printed circuit boards (PCBs).

InvenSense's 3-axis gyroscopes have a shock tolerance of 10,000g. InvenSense packages its gyroscopes as it deems proper for protection against normal handling and shipping. It recommends the following handling precautions to prevent potential damage.

- Individually packaged or trays of gyroscopes should not be dropped on hard surfaces. Components placed in trays could be subject to *g*-forces in excess of 10,000*g* if dropped.
- Printed circuit boards that incorporate mounted gyroscopes should not be separated by manually snapping apart. This could also create *g*-forces in excess of 10,000*g*.

9.12 Gyroscope Surface Mount Guidelines

Any material used in the surface mount assembly process of the MEMS gyroscope should be free of restricted RoHS elements or compounds. Pb-free solders should be used for assembly.

In order to assure gyroscope performance, several industry standard guidelines need to be considered for surface mounting. These guidelines are for both printed circuit board (PCB) design and surface mount assembly and are available from packaging and assembly houses.

When using MEMS gyroscope components in plastic packages, package stress due to PCB mounting and assembly could affect the output offset and its value over a wide range of temperatures. This is caused by the mismatch between the Coefficient Temperature Expansion (CTE) of the package material and the PCB. Care must be taken to avoid package stress due to mounting.

9.13 Reflow Specification

The approved solder reflow curve shown in the figure below conforms to IPC/JEDEC J-STD-020C (reflow) with a maximum peak temperature (255 +5/-0°C). This is specified for component-supplier reliability qualification testing using lead-free solder. All temperatures refer to the topside of the QFN package, as measured on the package body surface. Customer solder-reflow processes should use the solder manufacturer’s recommendations, making sure to never exceed the constraints listed in the table and figure below, as these represent the maximum tolerable ratings for the device. For optimum results, production solder reflow processes should use lower temperatures, reduced exposure times to high temperatures, and lower ramp-up and ramp-down rates than those listed below.

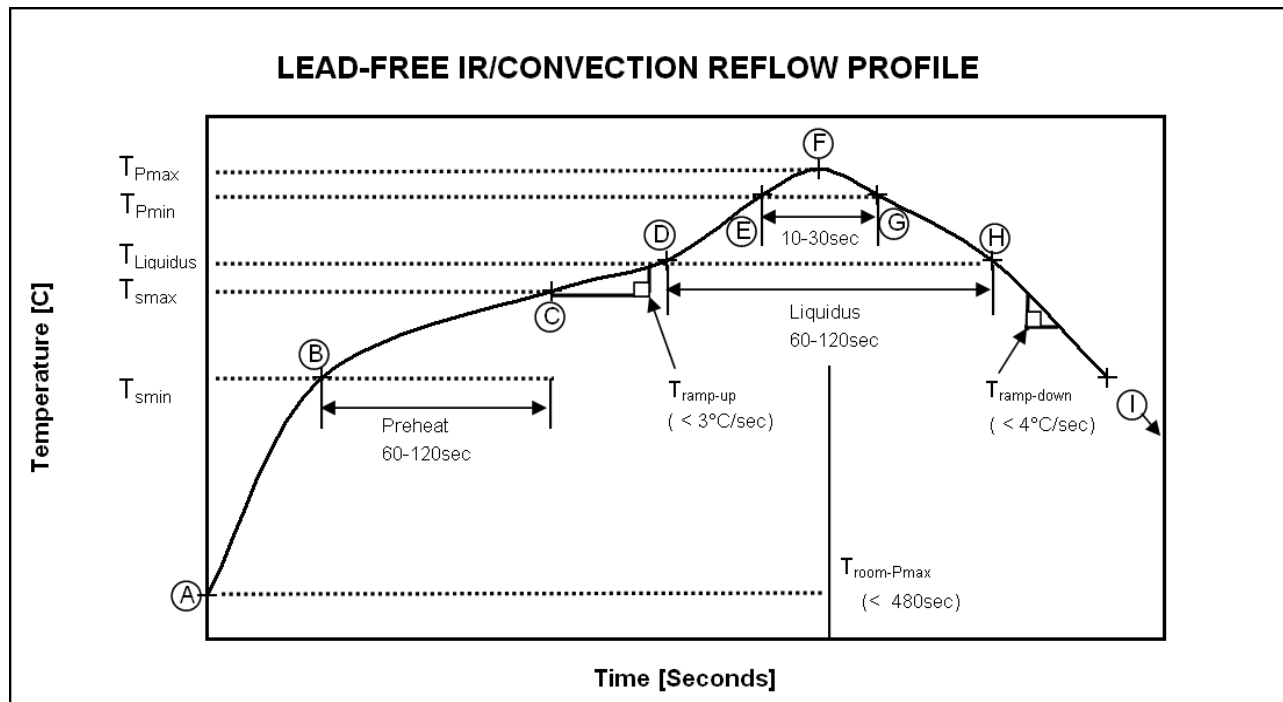

Approved IR/Convection Solder Reflow Curve



Temperature Set Points for IR / Convection Reflow Corresponding to Figure Above

Step	Setting	CONSTRAINTS		
		Temp (°C)	Time (sec)	Rate (°C/sec)
A	Troom	25		
B	TSmin	150		
C	TSmax	200	60 < tBC < 120	
D	TLiquidus	217		r(TLiquidus-TPmax) < 3
E	TPmin [< TPmax-5°C, 250°C]	255		r(TLiquidus-TPmax) < 3
F	TPmax [< TPmax, 260°C]	260	tAF < 480	r(TLiquidus-TPmax) < 3
G	TPmin [< TPmax-5°C, 250°C]	255	tEG < 30	r(TPmax-TLiquidus) < 4
H	TLiquidus	217	60 < tDH < 120	
I	Troom	25		

9.14 Storage Specification

The storage specification of the IXZ-650 gyroscope conforms to IPC/JEDEC J-STD-020C Moisture Sensitivity Level (MSL) 3.

Storage Specifications for IXZ-650

Calculated shelf-life in moisture-sealed bag	12 months -- Storage conditions: <40°C and <90% RH
After opening moisture-sealed bag	168 hours -- Storage conditions: ambient ≤30°C at 60% RH

	IXZ-650 Dual-Axis Gyroscope Product Specification	PS-IXZ-0650B-00-03 Release Date: 05/20/10
---	--	--

10. Reliability

10.1 Qualification Test Policy

InvenSense's products complete a Qualification Test Plan before being released to production. The Qualification Test Plan follows the JEDEC 47D Standards, "Stress-Test-Driven Qualification of Integrated Circuits," with the individual tests described below.

10.2 Qualification Test Plan

Accelerated Life Tests

TEST	Method/Condition/	Lot Quantity	Sample / Lot	Acc / Reject Criteria
High Temperature Operating Life (HTOL/EFR)	JEDEC JESD22-A108C, Dynamic, 3.63V biased, Tj>125°C [read-point 24 Hours]	3	500	(1/2)
High Temperature Operating Life (HTOL/LFR)	JEDEC JESD22-A108C, Dynamic, 3.63V biased, Tj>125°C [read-points 168, 500, 1000 hours]	3	77	(0/1)
Steady-State Temperature Humidity Bias Life ⁽¹⁾	JEDEC JESD22-A101C, 85°C/85%RH [read-points 168, 500 hours], Information Only 1000 hours]	3	77	(0/1)
High Temperature Storage Life	JEDEC JESD22-A103C, Cond. A, 125°C Non-Bias Bake [read-points 168, 500, 1000 hours]	3	77	(0/1)

Device Component Level Tests

TEST	Method/Condition/	Lot Quantity	Sample / Lot	Acc / Reject Criteria
ESD-HBM	JEDEC JESD22-A114F, Class 2 (2KV)	1	15	(0/1)
ESD-MM	JEDEC JESD22-A115-A, Class B (200V)	1	12	(0/1)
Latch Up	JEDEC JESD78B Level 2, 125C, +/- 100mA	1	6	(0/1)
Mechanical Shock	JEDEC JESD22-B104C, Mil-Std-883, method 2002, Cond. D, 10,000g's, 0.3ms, ±X,Y,Z – 6 directions, 5 times/direction	3	5	(0/1)
Vibration	JEDEC JESD22-B103B, Variable Frequency (random), Cond. B, 5-500Hz, X,Y,Z – 4 times/direction	3	5	(0/1)
Temperature Cycling ⁽¹⁾	JEDEC JESD22-A104D Condition N, -40°C to +85°C, Soak Mode 2, 100 cycles	3	77	(0/1)

Board Level Tests

TEST	Method/Condition/	Lot Quantity	Sample / Lot	Acc / Reject Criteria
Board Mechanical Shock	JEDEC JESD22-B104C, Mil-Std-883, method 2002, Cond. D, 5000g's, 0.3ms, ±X,Y,Z – 6 directions, 5 times/direction	1	5	(0/1)
Board T/C	JEDEC JESD22-A104D Condition N, -40°C to +85°C, Soak Mode 2, 100 cycles	1	40	(0/1)
Board Mechanical Vibration	JEDEC JESD22-B103B, Variable Frequency (random), Cond. B, 5-500Hz, X,Y,Z – 4 times/direction	3	5	(0/1)
Board Bend test	JESD22B113, Information Only	4	8	N/A

(1) – Tests are preceded by MSL3 Preconditioning in accordance with JEDEC JESD22-A113F



IXZ-650 Dual-Axis Gyroscope Product Specification

PS-IXZ-0650B-00-03
Release Date: 05/20/10

11. Environmental Compliance

The IXZ-650 gyroscope is RoHS and Green compliant.

Device: IXZ-650B
Package Type: QFN 28L 4x5x1.2mm
Package Total Mass (mg): 58.60

Component	Substance	CAS Number	Percent (%)	Material Weight (mg)	Amount of Substance (mg)
-----------	-----------	------------	-------------	----------------------	--------------------------

Semiconductor Device

Silicon Chip	Doped Silicon	7440-21-3	100	11.41	11.41
--------------	---------------	-----------	-----	-------	-------

Lead Frame (C7205 QFN MATRIX ETCH ASM)

Base Metal	Copper (Cu)	7440-50-8	Balance	10.32	9.949
Base Metal	Iron (Fe)	7439-89-6	2.1-2.6		0.243
Base Metal	Phosphorus (P)	7723-14-0	0.015-0.15		0.009
Base Metal	Zinc (Zn)	7440-66-6	0.05-0.20		0.013
Plating	Nickel (Ni)	7440-02-0	0.97		0.100
Plating	Palladium (Pd)	5/3/7440	0.06		0.006
Plating	Gold (Au)	7440-57-5	0.01		0.001

Bond Wire (GOLD WIRE 1.00MIL GLD TANAKA)

Metal Wire	Gold	7440-57-5	99.99 Min	0.56	0.563
------------	------	-----------	-----------	------	-------

Die Attach Adhesive (DA 6501 DOW CORNING – NON-CONDUCTIVE)

Filler	Dimethyl Siloxane, Dimethylvinylsiloxy-Terminated	068083-19-2	Balance	1.34	1.166
Filler	Trimethylated Silica	068909-20-6	7 - 13		0.137
Filler	Dimethyl, Methylhydrogen Siloxane, Hydrogen-Terminated	069013-23-6	1 - 5		0.040

Mold Compound (COMPOUND GREEN CEL 9220HF13H HITACHI)

Filler	Epoxy Resin-1	Trade Secret	2 - 5	34.96	1.224
Filler	Epoxy Resin-2	Trade Secret	1 - 3		0.699
Filler	Phenol Resin	Trade Secret	2 - 5		1.224
Hardener	Silica	60676-86-0	Balance		28.076
Coloring Material	Carbon Black	1333-86-4	Approx. 0.2		0.070
Filler	Metal Hydroxide	Trade Secret	1 - 10		1.923
-	Others	-	Max. 5		1.748

Test results for ROHS banned substances/compounds

Substances/Compound	Test Method	Die	Lead-frame	Bond Wire	Die Attach Adhesive	Mold Compound
Hexavalent Chromium	US EPA Method 3060A & 7196A, IEC 62321/2nd CDV (111/95/CDV), ICP/AES	ND (< 1)	ND (< 2)	ND (< 2)	ND (< 2)	ND (< 2)
Cadmium	US-EPA Method 3052, IEC 62321/2nd CDV (111/95/CDV), ICP/AES	ND (<1)	ND (<2)	ND (<2)	ND (<2)	ND (<2)
Mercury	US-EPA Method 3052, IEC 62321/2nd CDV (111/95/CDV), ICP/AES	ND (<1)	ND (<2)	ND (<2)	ND (<2)	ND (<2)
Lead	US-EPA Method 3050B IEC 62321/2nd CDV (111/95/CDV), ICP/AES	1.5	ND (<2)	ND (<2)	ND (<2)	ND (<2)
PBBs	US-EPA Method 3540C/ 3550B IEC 62321/2nd CDV (111/95/CDV), UV/Vis	ND (<1)	ND (<5)	ND (<5)	ND (<5)	ND (<5)
PBDEs	EPA 3540C/ 3550B, IEC 62321/2nd CDV (111/95/CDV) UV/Vis	ND (<1)	ND (<5)	ND (<5)	ND (<5)	ND (<5)
Organic Bromines	US-EPA Method 8260B, GC/MS	ND (<1)	Whole device	Whole device	Whole device	Whole device
Phthalates	GC/MS	ND (<1)	Whole device	Whole device	Whole device	Whole device

ND = Not Detected

Environmental Declaration Disclaimer:

InvenSense believes this environmental information to be correct but cannot guarantee accuracy or completeness. Conformity documents for the above component are on file. InvenSense subcontracts manufacturing and the information contained herein is based on data received from vendors and suppliers. This information has not been validated by InvenSense.



**IXZ-650 Dual-Axis Gyroscope
Product Specification**

PS-IXZ-0650B-00-03
Release Date: 05/20/10

This information furnished by InvenSense is believed to be accurate and reliable. However, no responsibility is assumed by InvenSense for its use, or for any infringements of patents or other rights of third parties that may result from its use. Specifications are subject to change without notice. InvenSense reserves the right to make changes to this product, including its circuits and software, in order to improve its design and/or performance, without prior notice. InvenSense makes no warranties, neither expressed nor implied, regarding the information and specifications contained in this document. InvenSense assumes no responsibility for any claims or damages arising from information contained in this document, or from the use of products and services detailed therein. This includes, but is not limited to, claims or damages based on the infringement of patents, copyrights, mask work and/or other intellectual property rights.

Certain intellectual property owned by InvenSense and described in this document is patent protected. No license is granted by implication or otherwise under any patent or patent rights of InvenSense. This publication supersedes and replaces all information previously supplied. Trademarks that are registered trademarks are the property of their respective companies. InvenSense sensors should not be used or sold in the development, storage, production or utilization of any conventional or mass-destructive weapons or for any other weapons or life threatening applications, as well as in any other life critical applications such as medical equipment, transportation, aerospace and nuclear instruments, undersea equipment, power plant equipment, disaster prevention and crime prevention equipment.

InvenSense™ is a registered trademark of InvenSense, Inc. IXZ™ and IXZ-650™ are trademarks of InvenSense, Inc.

©2009 InvenSense, Inc. All rights reserved.